

剖视图

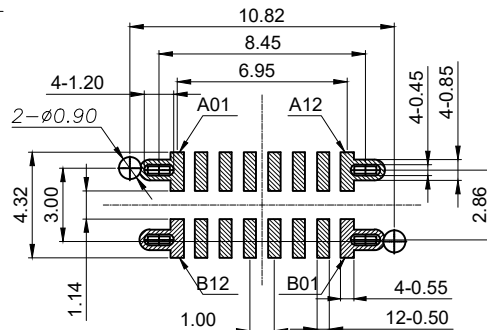

RECOMMENDED P.C.B. LAYOUT (俯视图)

TOLERANCE UNSPECIFIED ±0.05mm

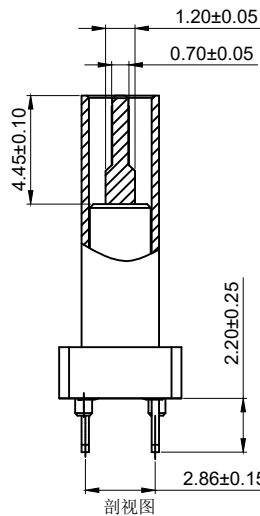
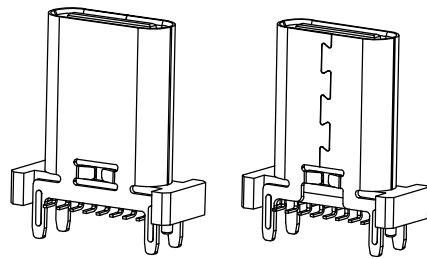
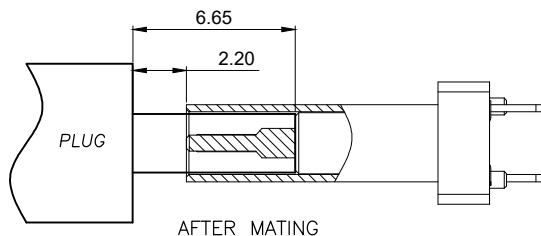
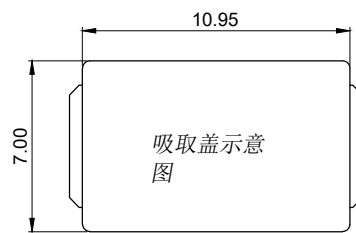
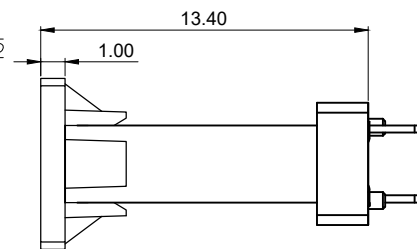
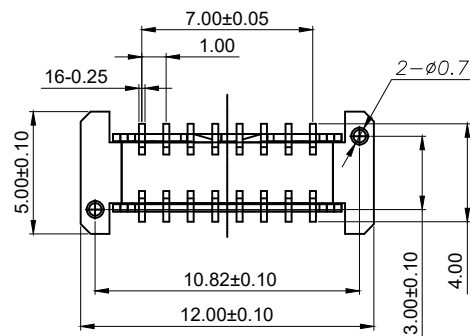

REV	DESCRIPTION	DATE	APPROVED

SPECIFICATION:

- ELECTRICAL:
 - CURRENT RATING:5A;
 - CONTACT RESISTANCE:40mΩ Max;
 - DIELECTRIC WITHSTANDING VOLTAGE:100V AC;
 - INSULATION RESISTANCE:100 MΩ MIN;
- MECHANICAL:
 - MATING FORCE:5~20N;
 - UNMATING FORCE:8~20N;
 - DURABILITY:10000 CYCLES;6~20N AFTER DURABILITY TEST;
- MATERIAL:
 - HOUSING&MOLDING:BLACK LCP UL94V-0;
 - TERMINAL:C7025 T=0.15mm;
 - SHELL:SUS304 T=0.30mm;
 - MID PLATE:SUS304 T=0.15mm;
- PLATING SPECIFICATION:
 - TERMINAL:CONTACT POINT GOLD PLATED 3u "MIN PIN WELDING AREA GOLD PLATED 1u" MIN.
 - SHELL:PLATED Ni 60u" MIN(Salt spray 48H)
- ELECTROPLATED PRODUCTS NEED TO UNDERGO TIN ADHESION TESTING: THE TIN ADHESION AREA SHOULD REACH OVER 95%.
- SMT REFLOW SOLDERING (PEAK VALUE 260 °C ± 5 ° C) SHALL BE FREE OF BLISTERING, GLUE MELTING AND POOR COLOR CHANGE (DEFORMATION WITHIN TOLERANCE)
- OPERATING TEMPERATURE: -40°C~+85°C

A1	GND	B12	GND
A4	VBUS	B9	VBUS
A5	CC1	B8	SBU2
A6	D+	B7	D-
A7	D-	B6	D+
A8	SBU1	B5	CC2
A9	VBUS	B4	VBUS
A12	GND	B1	GND
PIN	SIGNAL NAME	PIN	SIGNAL NAME

CUSTOMER DRAWING		
UNITS mm	SCALE 1:1	SHEET 1 OF 2
PROJECTION: 	DRAW: DAP	
GENERAL TOLERANCE X. ±0.25 X.x ±0.20 X.xx ±0.15 X.xxx ±0.10 ANGLES ±2°	CHECK: HWT	DWG. NO. A031607A
	APPD: HHM	

铭创科技 (东莞) 有限公司 Mingchuang Technology (Dongguan) Co., Ltd		
TITLE TYPE C母座16PIN 立式四脚插板SMT L=12.4 A款		
MAT'L SEE TABLE	FINISH SEE TABLE	
PART NO. _____		SIZE A4

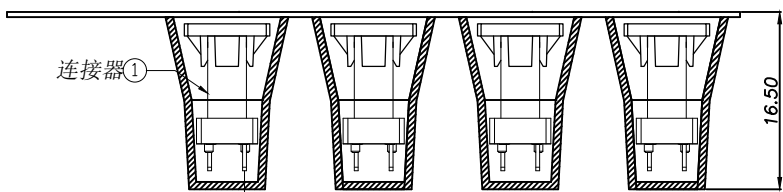
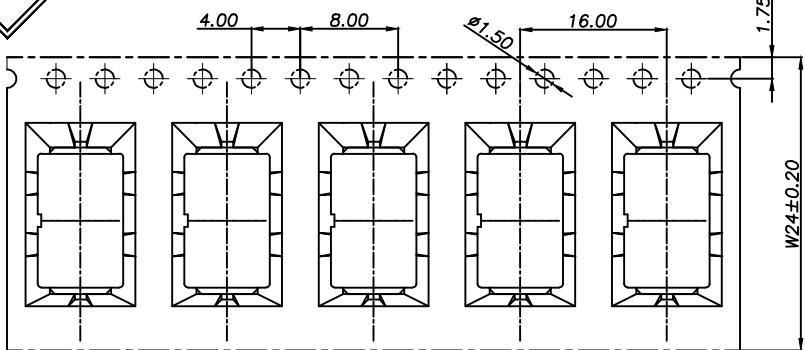

产品入载带示意图

剥离角度: 165°~180°
剥离力: 40gf~120gf
用户取件方向

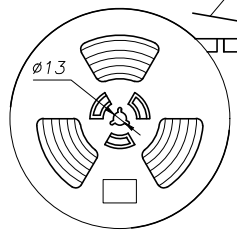
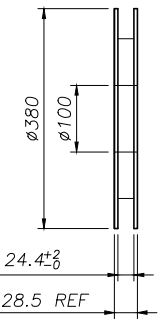

卷盘示意图

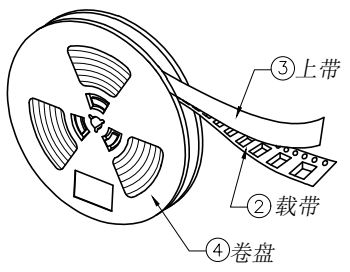

REV	DESCRIPTION	DATE	APPROVED
-----	-------------	------	----------

包装示意图

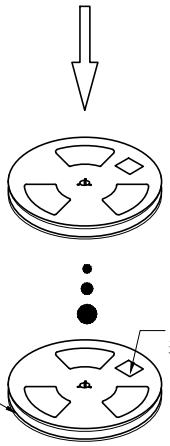

卷盘贴标签示意图

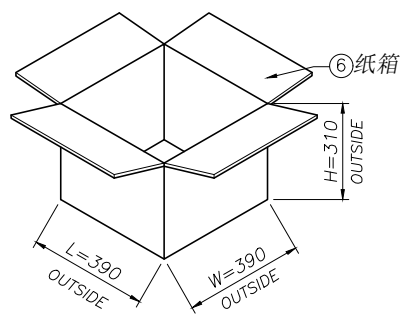
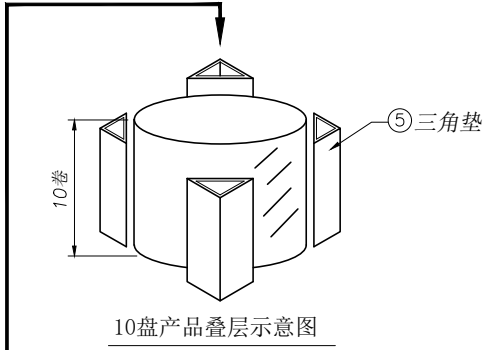

技术要求:

1. 载带首尾各留出 7PCS 空格 不装产品;
2. 每穴放置 1PCS 产品, 每卷装 370PCS 产品, 放置方式如图所示;
3. 将包装好的产品;每盘必需贴上内标签;将贴好内标签的产品每10盘堆叠.
4. 在纸箱四角垫上 4 个三角垫, 然后把装好产品的卷盘放入纸箱中, 最后用胶带封箱;
(如客户有要求, 请按客户要求包装出货)
5. 上带与载带的剥离力: 40gf~120gf, 跳动量在 30gf 内;
(剥离角度: 165°~180°, 剥离速度: 250~300mm/min)
6. 产品符合 RoHS 环保标准要求.

06	纸箱	B-05-0012	390mm*390mm*310mm	1 PCS
05	三角垫	/	300mm*260mm*7mm	4 PCS
04	卷盘	/	D=380mm, d=100mm, H=28.5mm	10 PCS
03	上带	/	W=21.3mm, T=0.05mm	6144 mm
02	载带	B-03-0035	W=24mm, T=0.50mm, P=16.0mm	6144 mm
01	连接器	A031607A	16PIN, SMT	3700 PCS
序号	物料名称	物料编号	规格	描述

CUSTOMER DRAWING		
UNITS mm	SCALE 1:1	SHEET 1 OF 2
PROJECTION: 	DRAW: DAP	
GENERAL TOLERANCE X. ±0.25 X.x ±0.20 X.xx ±0.15 X.xxx ±0.10 ANGLES ±2°	CHECK: HWT	MAT'L SEE TABLE
	APPD: HHM	
	DWG. NO. A031607A	

铭创科技 (东莞) 有限公司 Mingchuang Technology (Dongguan) Co., Ltd		
TITLE TYPE C 母座 16PIN 立式四脚插板 SMT L=12.4 A 款		
DWG. NO. A031607A		PART NO. _____
SIZE A4		